

IQsafeLinkTM

Datasheet

IQsafeLink v3 Advanced



Version:

August 1st 2016

IQsafeLink

A product of Armac B.V.

Adres
Buskesdries 2
6673 DP

E-mail info@armac.nl
Tel. +31 (0) 488 451 236
Fax +31 (0) 488 452 367
Web www.armac.nl
www.iqsafelink.com

BTW NL8072.35.465.B.01
Bank NL11RABO0133944441
BIC RABONL2UAndelst
KvK 100.35.834

Table of contents

1	Hardware specifications	4
2	Dimensions	5
3	Connect	8
3.1	Power	8
3.2	Serial	8
3.3	General	9

1 Hardware specifications

ENCLOSURE	
DIMENSIONS	180 x 134 x 50 mm (WxDxH)
WIEGHT	± 1 Kg
CPU	Intel BayTrail Quad Core J1900
MEMORY	4Gb RAM
STORAGE CAPACITY	64Gb SSD
POWER	
INCOMMING POWER	16-30 VDC
EMC GUIDELINE	
EMC	EN55022 class B
INTERFACES	
USB2.0	4x
USB3.0	1x
WAN	1x
HDMI	1x
VGA	1x
COM	2x
OPERATING SYSTEM	
CORE	Linux
VIRTUAL MACHINE	Microsoft Windows 7 64bit
ENVIRONMENT	
COOLING	PASSIVE
TEMPERATURE	0 – 50 °C
HUMIDITY	10% - 90% @ 39 °C, non condensing

2 Dimensions

The dimensions of the IQsafelink are:

Height 55 mm

Depth 116 mm

Width 178 mm

An IQsafeLink has two COM-ports (BIOS configurable), two ethernetports, one HDM-port one VGA-port four USB2.0-ports and one USB3.0-port.

The HDMI and VGA ports are for service purposes only.

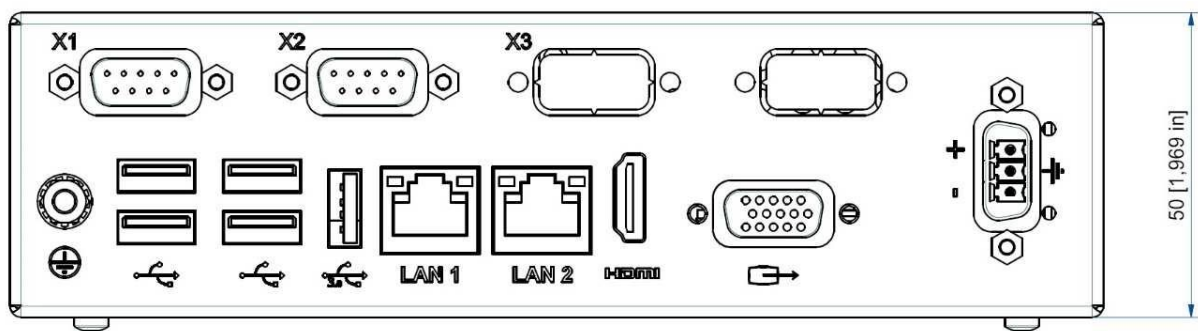

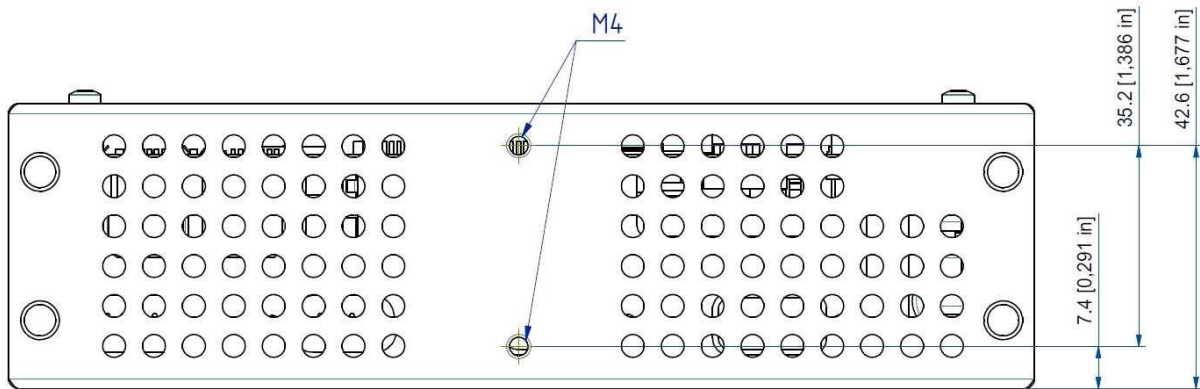
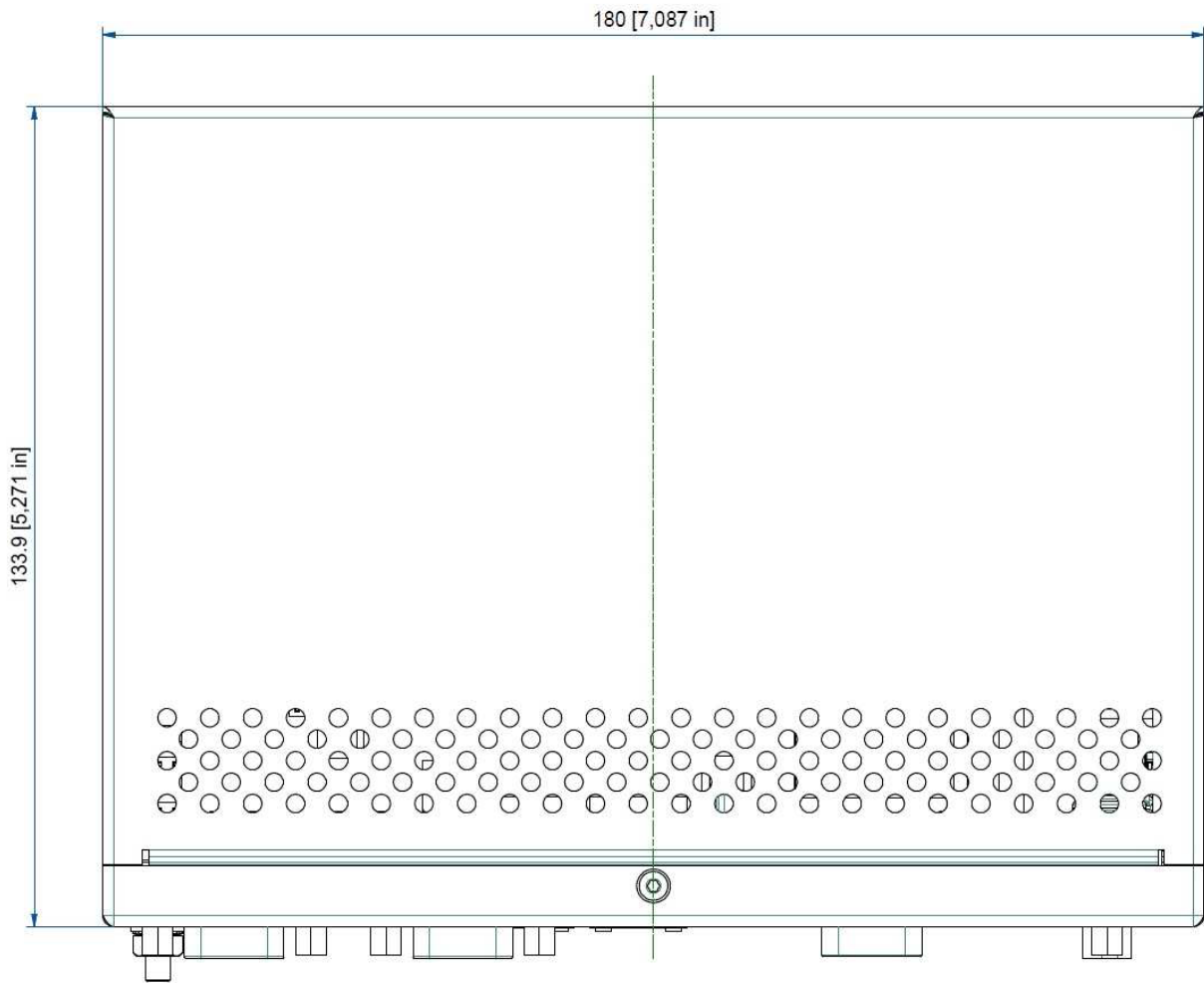

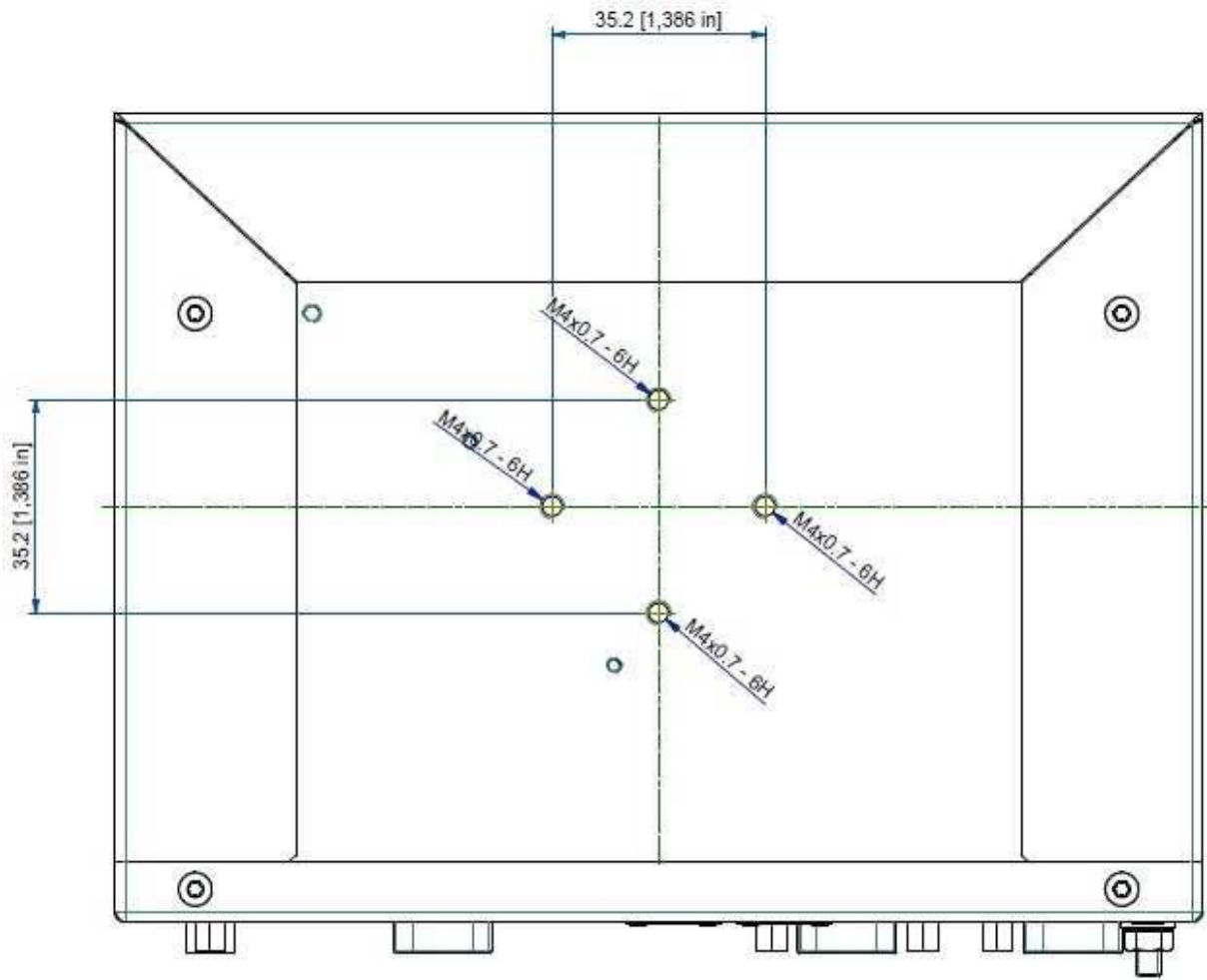

Max. M4x6

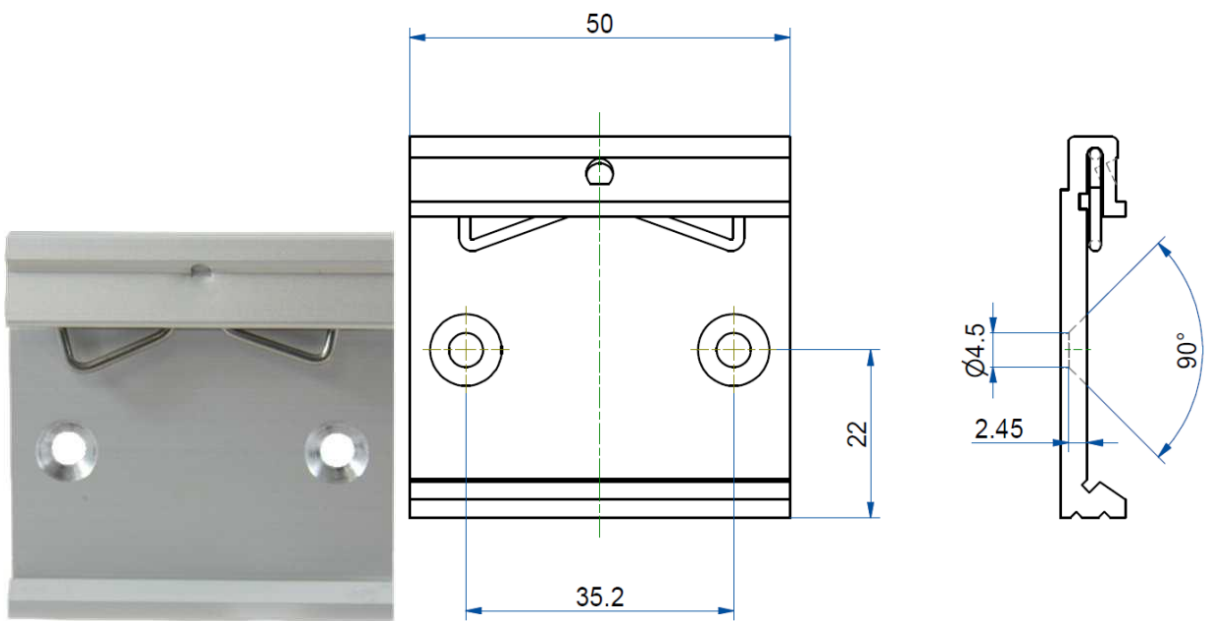

Max. M4x8



3 Connect

3.1 Power

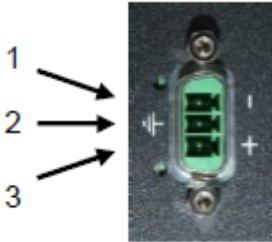

Pin	Signal
1	GND
2	Shield
3	VCC

3.2 Serial

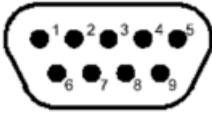

Pin	RS-232	RS-422	Half Duplex RS-485	Full Duplex RS-485
1	DCD	Tx-	DATA-	Tx-
2	RxD	Tx+	DATA+	Tx-
3	TxD	Rx+	-	Rx+
4	DTR	Rx-	-	Rx-
5	GND	GND	GND	GND
6	DSR	-	-	-
7	RTS	-	-	-
8	CTS	-	-	-
9	RI	-	-	-

3.3 General

